

HTB-683L / HTB-686L B/W CCD CAMERA

SPECIFICATOINS

ITEM NO.	HTB-683L	HTB-686L
PICK UP DEVICE	1/3" CCD IMAGE SENSOR	
ELEMENTS H*V	EIA: 510 * 492—CCIR: 512 * 582	EIA: 771 * 494—CCIR: 753 * 582
HORIZONTAL RESOLUTION	More than 420 TV Lines	More than 580 TV Lines
SYNCHRO FREQUENCY	EIA: 15.734 kHz / 60 Hz – CCIR: 15.625 kHz / 50 Hz	
SCANNING SYSTEM	2 : 1 INTERLANCE	
SENSITIVITY	0.01 Lux F=1.2	0.1 Lux F=1.2
SYNCHRONIZATION	LINE LOCK	
S/N RATIO	MORE THAN 48 dB	
AES(AUTO GAIN CONTROL)	Up to 1/100,000 sec. (linear) ON/OFF Switchable	
VIDEO OUTPUT	1 Vpp, 75 Ohms Composite	
AUTO IRIS	Video Driver / DC Driver Switchable	
MOUNT LENS	CS Mount	
POWER SUPPLY	24V AC	
POWER CONSUMPTION	3W	3.5W
AUTO GAIN CONTROL	ON/OFF Switchable	
BACK LIGHT COMPENSATION	ON/OFF Switchable	
DIMENSIONS (D * W * H)mm	85 * 59 * 59	
WEIGHT gr	680	
STORAGE TEMPERATURE	-30 to + 60 Degree C	
OPERATON TEMPERATURE	-10 to + 40 Degree C	

*SPECIFICATIONS ARE SUBJECT TO CHANGE WITHOUT NOTICE.

CAUTIONS

1. In order to protect the camera, avoid placing or using it under direct sunlight, rain or dust.
2. Don't touch the CCD sensor directly with your fingers. If necessary, use soft cloth moistened with alcohol to wipe off the dust.
3. When the camera is not in use, keep the lens, or cap being attached to protect the CCD sensor.
4. AC model: directly connect to AC power source.
5. Don't drop your camera or give it a strong shock or vibration.

CONNECTION

1. Before connection, make sure that power of all units are OFF and cords are unplugged.
2. Mount a lens onto the camera.
3. Connect a video terminal of the camera and the video input terminal of a monitor TV with a 75 Ω coaxial cable.
4. Connect the power terminal of the camera to a power supply.

Caution:

* Installation should conform to all local codes.

* Lens, coaxial cable for video signal and power supply are not supplied with the camera.

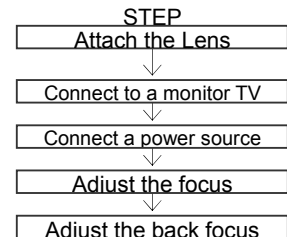

LOCATIONS, FUNCTION OF PARTS & ACCESSORIES

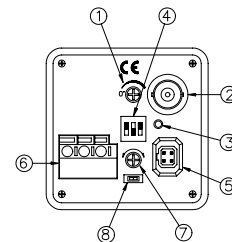
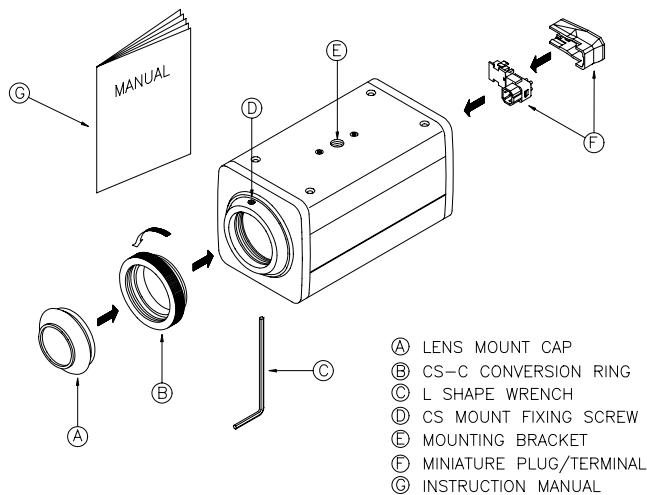

AC 24V

- ① V. PHASE OF LINE LOCK
- ② VIDEO OUT BNC(F) JACK
- ③ POWER IDICATOR LED
- ④ DIP SWITCH
- ⑤ 4 PIN-SOCKET FOR AUTO IRIS OR DC DRIVER LENS
- ⑥ POWER SUPPLY
- ⑦ DC DRIVER LEVEL
- ⑧ DC/VIDEO DRIVER SWITCH

OPERATIONS AND ADJUSTMENTS

1. Connect the power cord and turn the power ON.
2. Adjust the iris and focus of the lens to obtain the optimum image.

* Using normal lenses

CS-mount lens mode is the standard type. When use C-mount lens, Please use the CS-C conversion Ring.

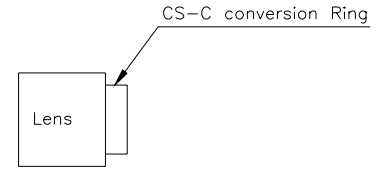

* Using the zoom lens (adjustment of the back focus)

The camera is set at the standard back focus position when shipped from factory. Depending on types of zoom lenses, however slight adjustment may be necessary. Adjust the lens back-focus by turning the focusing knob in either direction.

- (1) Place an object at any fixed distance and set the focus ring of the zoom lens to be used with.
- (2) Set the zoom lens to fully TELE position and obtain the best focus position by turning the focus ring of the zoom.
- (3) Then set the zoom lens to fully WIDE position and obtain the best focus position by turning the focusing knob.
- (4) Repeat the procedures 2 and 3 until focus remains in constant among the zoom range.

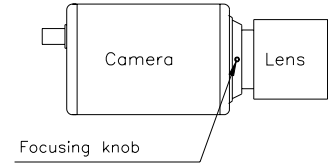

* Using an auto iris lens

NOTE: Don't use both SHUTTER ON & AUTO IRIS lens at the same time.

(DC driver lens)

When auto iris lens is used, set AI DRIVER switch to DC position and connect the plug of the lens (for iris terminal) to the IRIS terminal on the back of camera.

DC Drive Level

When you use an DC Driver Lens you can adjust the DC Drive Level for the bright of video output.

(Video Driver lens)

When auto iris is used, AI DRIVER switch to VIDEO position and to connect the plug of the lens (for iris terminal) to the IRIS terminal on the back of the camera.

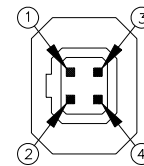
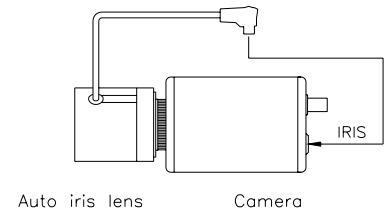

DC		VIDEO
1. DAMP (-)		1. DC 12V
2. DAMP (+)		2. NC
3. DRIVER (+)		3. IRIS SIGNAL
4. DRIVER (-)		4. GND

CAMERA CONTROLLER

Dip Switch

1. BLC (BACK LIGHT COMPENSATION)

As you take a picture with strong light behind the subject, the picture would be looked very dim on the subject. In this case, you should select BLC ON to get a clear image.

NOTE: When you select BLC ON than the SHUTTER should be in ON position or use Auto Iris Lens.

2. AES

By setting the AES switch to ON, the AES mode (Up to 1/100,000) sec) is available.

For shooting fast-moving objects or high brightness environment, the various electronic shutter speed can change automatically.

Note: The picture may flicker under fluorescent lamp. In this case, please select FLICKERLESS function.

*** If you choose the FLICKERLESS function, please set the SHUTTER switch to OFF position.**

3. AGC

Choose AGC ON as taking a picture at night will get a better image than the one without such function.

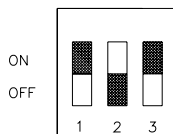

SWITCH (ON)	ON	OFF	USAGE
1. BLC	YES	NO	BACK LIGHT COMPENSATION
2. AES	YES	NO	WHEN NOT USE THE IRIS LENS
3. AGC	SENSE-UP	NORMAL 18 dB	WHEN LIGHT SOURCE IS INSUFFICIENT

LINE LOCK

When two or more cameras are switched by the video switcher, quad or multiplexer for monitoring on a TV monitor. The picture may fluctuate due to different AC line phase of each camera, In this case, please select the Line Lock function.