

The lightning flash with an arrowhead symbol, within an equilateral triangle is intended to alert the user to the presence of uninsulated dangerous voltage within the product's enclosure that may be of sufficient magnitude to constitute a risk of electric shock to persons.



The exclamation point within an equilateral triangle is intended to alert the user to the presence of important operating and maintenance (servicing) instructions in the literature accompanying the appliance.

**INFORMATION** - This equipment has been tested and found to comply with limits for a Class A digital device, pursuant to part 15 of the FCC Rules & CE Rules. These limits are designed to provide reasonable protection against harmful interference when the equipment is operated in a commercial environment. This equipment generates, uses, and can radiate radio frequency energy and, if not installed and used in accordance with the instruction manual, may cause harmful interference to radio communications. Operation of this equipment in a residential area is likely to cause harmful interference in which case the user will be required to correct the interference at his own expense.

**WARNING** - Changes or modifications not expressly approved by the manufacturer could void the user's authority to operate the equipment.

**CAUTION** : To prevent electric shock and risk of fire hazards:

- ◆ Do NOT use power sources other than those specified.
- ◆ Do NOT expose this appliance to rain or moisture.

This installation should be made by a qualified service person and should conform to all local codes.

## ■ Contents

<b>Features</b>	4
<b>Warnings and Precautions</b>	5
<b>Components</b>	8
<b>Names and Functions of Parts</b>	9
■ Lens	10
■ OSD	10
■ VBS-EXTRA	11
■ 3 Axis Bracket	11
<b>Dimensions</b>	11
<b>Installation</b>	12
<b>Cable Connection</b>	12
<b>Installation</b>	14

<b>How to Use the Camera</b>	15
■ Function Menu Structure	15
■ How to Set up the Functions	16
• LENS	17
• EXPOSURE	19
• WHITE BALANCE control	21
• BACKLIGHT	22
• DNR (Digital Noise Reduction)	24
• DAY/NIGHT	25
• IMAGE ADJ	27
• SPECIAL	29
• EXIT	33
<b>Troubleshooting</b>	34
<b>Specifications</b>	36

## ■ Features

### Ultra High Resolution

By adopting a double-speed 410,000 pixel Sony CCD, the camera produces clear picture quality with a horizontal resolution of 580 TV lines for color, and 700 TV lines for B/W.

### Excellent Sensitivity

Adopting a Diagonal 6mm (1/3"), highly sensitive CCD and digital signal processing technology, it can clearly distinguish the outline and color of a subject in an extremely low luminance environment. even, for example, under starlight. Since surveillance is possible in places where the light is poor, the camera is appropriate for day and night surveillance outdoors or on the outside of buildings.

### DNR (Digital Noise Reduction)

The amount of low illuminance noise has been significantly reduced, and the signal-to-noise ratio (S/N ratio) as well as horizontal resolution have been improved, resulting in a clear and sharp image display even in the dark.

### Motion Detection

The camera detects motion and generates a screen message without an external sensor.

### DIS (Digital Image Stabilizer)

The DIS function compensates for any camera movement, to produce more stable pictures.

### Day & Night

The camera identifies whether it is day or night and automatically switches to the appropriate mode, depending on its environment. By day, the camera switches to color mode in order to maintain optimal color. At night, it switches to B/W mode so as to obtain better picture definition.

### Miscellaneous Functions

SYNC (INT/LL), SENS-UP, FREEZE, FLIP (HV-REV), D-ZOOM, SHARPNESS, MOTION DETECTION and PRIVACY functions are provided.

### RS-485 Communication Control Support

Remote OSD menu control via an RS-485 interface is supported.

### OSD

The camera control is convenient by using 7 different foreign language O.S.D.  
- NTSC : Korean, English, Spanish, Japanese  
- PAL : English, French, German, Spanish, Italian, Chinese

### 3 Axis built-in 100mm Dome Housing

## Warning ■

### The camera requires periodic inspection.

Contact an authorised technician to carry out the inspection.

### Stop using your camera when you find it malfunctioning.

If the camera emits smoke or is unusually hot for a long period, a fire may be caused.

### Do not install the camera on a surface that can not support it.

If the camera is installed on an inappropriate surface, it may fall and cause injury.

### Do not hold plug with wet hands.

It could cause an electric shock.

### Do not dis-assemble the camera.

It may result in an electric shock or other hazards.

### Do not use the camera close to a gas or oil leak.

It may result in a fire or other hazards.

## ■ Precautions

**Do not install the camera in extreme temperature conditions.**



Only use the camera under conditions where temperatures are between  $-10^{\circ}\text{C}$  and  $+50^{\circ}\text{C}$ . Be especially careful to provide ventilation when operating under high temperatures.

**Do not install or use the camera in an environment where the humidity is high.**



It can cause the image quality to be poor.

**Do not install the camera under unstable lighting conditions.**

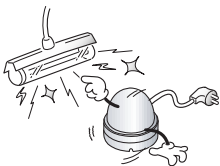

Severe lighting change or flicker can cause the camera to work improperly.

**Do not touch the front lens of the camera.**



This is one of the most important parts of the camera. Be careful not to leave fingerprints on the lens cover.

**Do not drop the camera or protect it from physical shocks.**



It can cause malfunctions to occur.

**Never keep the camera pointed directly at strong light.**

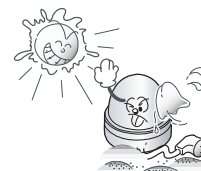

It can damage the CCD.

**Do not expose the camera to rain or spill beverage on it.**



If it gets wet, wipe it dry immediately. Liquids can contain minerals that corrode the electronic components.

**Do not expose the camera to radioactivity.**



If exposed to radioactivity the CCD will fail.

### Note

- If the camera is exposed to spotlight or object reflecting strong light, smear or blooming may occur.
- Please check that the power satisfies the normal specification before connecting the camera.

## ■ Components

1. COLOR DOME CAMERA .....

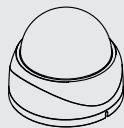

2. SCREWS .....



3. WIRE FOR VBS-EXTRA .....



4. INSTRUCTION GUIDE .....



## Names and Functions of Parts ■

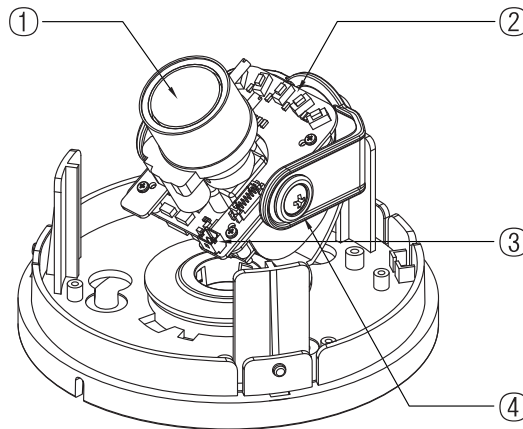

## Names and Functions of Parts

### ① LENS : Vari-Focal DC Auto Iris Lens

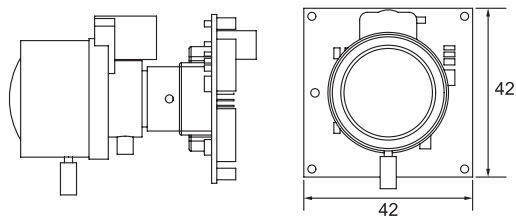

### ② OSD PCB

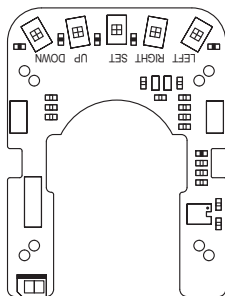

- **SET button** : Used for the menu display. This button can be used to confirm settings after changing the value of the selected function or current conditions.
- **UP & DOWN buttons** : Used for selecting items by moving the cursor up or down on the menu screen.
- **LEFT & RIGHT buttons** : Used when changing item values, by moving the cursor to the left or right on the menu screen.

## Names and Functions of Parts

### ③ VBS-EXTRA FOR CONNECTING TO LCD

Please use the supplied wire when connecting to external monitor

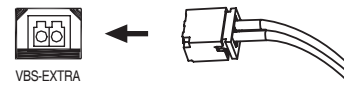

### ④ 3 AXIS BRACKET

Adjust the pan and tilt to give the correct angle of view.

## Dimensions

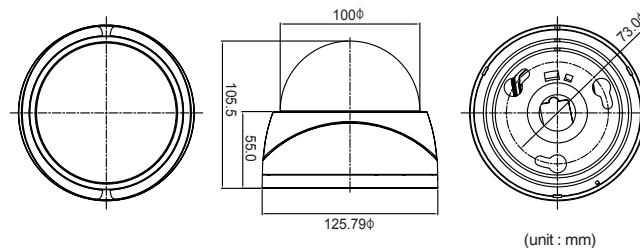

## ■ Installation

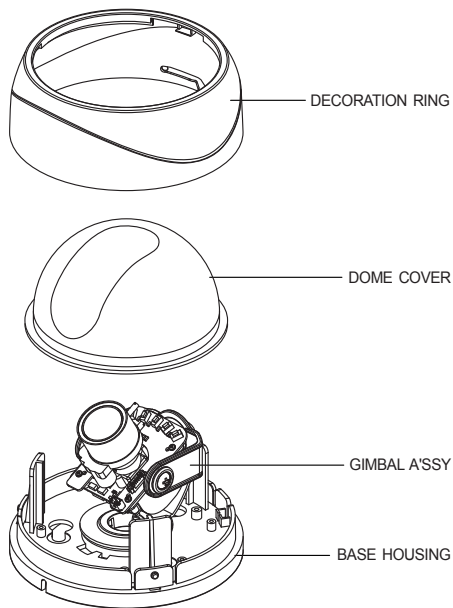

## ■ Cable Connections

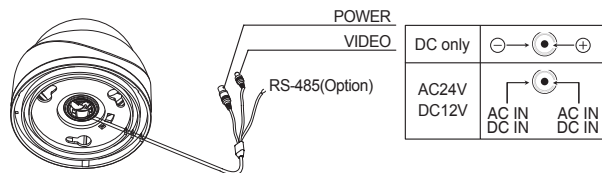

### 1. Dome Base Mounting

- Open the dome cover by loosening 3 screws using special wrench provided.
- Mount the base of camera to a sturdy surface using 4 screws (1.5 inch) and 4 premade holes on the base of the dome.

### 2. Power Connect & Monitor Impedance

- DC12V/300mA regulated power supply (DC12V only)
- AC24V Class 2 power supply (AC24V/DC12V)
- To avoid fire or shock hazard, must use a UL listed power supply.
- Set the monitor impedance switch to 75Ω. Check the impedance switch when the screen turns blurred.

### 3. Camera Module Adjustment

- Loosen screws for 3-axis camera bracket and adjust the direction and angle of camera.
- Make sure to retighten the screws for camera bracket.
- Set any function you wish to activate by using the OSD buttons.

### 4. Dome Cover Mounting

- Replace the dome cover to the base and tighten 3 screws.

## Control via RS-485 Interface

The camera can be controlled by using external controllers like a Remote controller. (RS-485 Communication)

- To control using a DVR or System Controller  
Connect the RS-485 cable (TRX+, TRX-) to the connection port of the 485 control board that is connected to the DVR or System Controller.

485 Control Board Connection Port	RS-485 Control Port
(+) CONNECTION TERMINAL (TRX+)	485+
(-) CONNECTION TERMINAL (TRX-)	485-

### Note

- To control the camera by constructing an additional controller, use Pelco-D protocol.  
(Go Preset 95 : Enters into OSD menu or Set key function)

## Installation

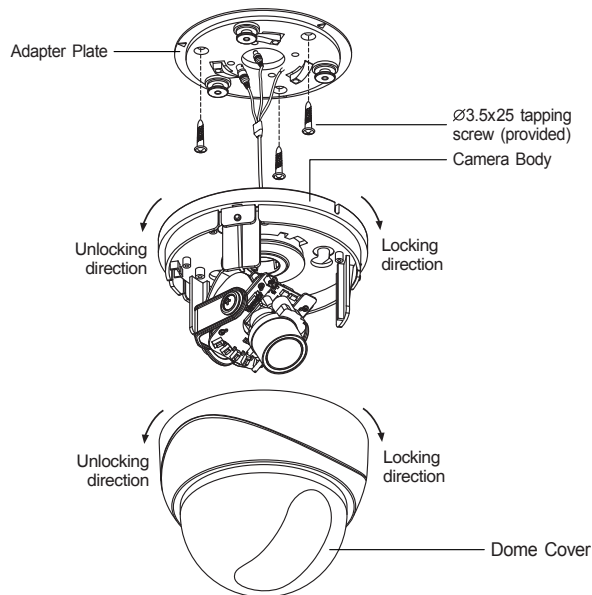

### \* When installing on an adapter plate bracket.

- ① Place the adapter plate bracket on a flat installation surface and fix it with the screws provided.
- ② When placing the camera body onto the plate, insert the plate pin into the corresponding holes on the camera body as shown in figure-1. Lock the camera in place by turning the camera body clockwise.
- ③ When placing the camera body on the plate, make sure that the power and video cables pass through.
- ④ After installation and adjustment of the camera is complete, secure the dome cover by turning it clockwise.

## How to Use the Camera

### Function Menu Structure

	Setup Menu
LENS	• DC      • MANUAL
EXPOSURE	• SHUTTER • AGC      • SENS-UP • RETURN
WHITE BALANCE	• ATW      • MANUAL • AWC SET • OUTDOOR • INDOOR
BACKLIGHT	• OFF      • BLC      • HLC
DNR	• ON      • OFF
DAY/NIGHT	• COLOR   • B/W      • AUTO • EXTERN
IMAGE ADJUSTMENT (IMAGE ADJ.)	• FREEZ   • V-REV   • H-REV • D-ZOOM   • SHARPNESS • RETURN
SPECIAL	• CAMTITLE • SYNC      • MOTION DET • PRIVACY   • DIS      • COMM ADJ • LANGUAGE • RESET   • RETURN
EXIT	

## How to Use the Camera

### How to Set up the Functions

Settings can be made using the 5 buttons located in the camera.

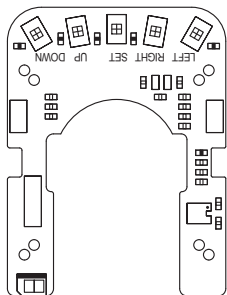

1. Press the SET button.
  - The Setup menu is displayed on the monitor screen.

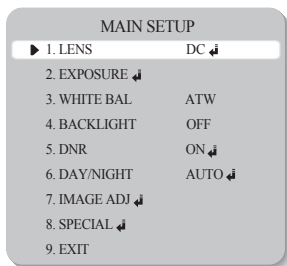

2. Select a menu item using the Up and Down buttons.
  - Place the cursor over a desired item.

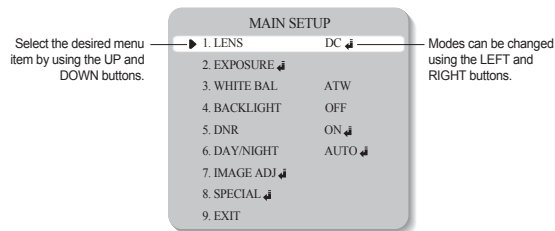

3. Set up a selected item by using the Left and Right buttons.
4. To finish and save the settings, select 'EXIT' and press the SET button.

#### Note

- An item with the ↕ icon also has sub-menus. To select a sub-menu, press the SET button.
- An item with the --- icon has no sub-menus available for selection.

### LENS

This function is used to adjust the brightness of the screen.

1. When the SETUP menu screen is displayed on the screen, position the cursor to point to LENS using the Up and Down buttons.
2. Select the type of lens using the Left and Right buttons.

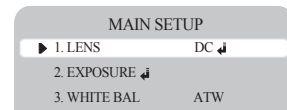

## How to Use the Camera

### ● DC : Select Auto Iris Lens

- When DC is selected, you can control screen brightness. The range of brightness control is between 1 and 70.  
Adjust the brightness appropriately for optimal screen brightness.



### Note

- Some lenses may not work properly, depending on the settings for the BRIGHTNESS LEVEL.
- When Using a Video-Type Auto Iris Lens
  - ① Check that the ALC adjustment on the lens is appropriate. In general, set it to AV (Average).
  - ② It may not work properly depending on the installed lens. Set the Level VR of the lens to the optimal value.
  - ③ Set AGC / SENS-UP to OFF and adjust the Lens VR to an appropriate brightness.
  - ④ Adjust the Lens VR, adjust the BRIGHTNESS, and then check if the screen brightness changes properly. Otherwise, adjust the Lens VR again.

### ● Manual : Select Manual Lens

## EXPOSURE

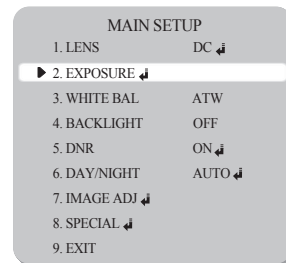

1. When the SETUP menu screen is displayed select EXPOSURE using the Up and Down buttons.
2. Select the desired mode using the Left and Right buttons.

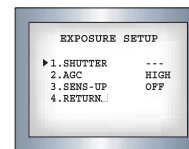

### ● SHUTTER : Select either auto or manual shutter.

- A.FLK : Select this when picture flicker is experienced, which can happen when there is a clash with the frequency of the installed lighting.
- ESC : Select this to control the shutter speed automatically. If ESC is selected, the shutter speed is automatically controlled according to the ambient illumination available.
- MANUAL : The shutter speed is controlled manually.

## ■ How to Use the Camera

### Note

- When the SHUTTER is set to ESC, and the camera is set to Internal Synchronisation, the picture may become unstable if the camera faces a bright fluorescent light. Therefore, take care when choosing the installation position.
- ESC and MANUAL modes are only available together when the lens is set to MANUAL.
- When the SHUTTER is set to MANUAL or A.FLK mode, SENS-UP is disabled.

### ● AGC (AUTO GAIN CONTROL):

The higher the gain level, the brighter the screen - but the higher the noise.

- OFF : Deactivates the AGC function.
- LOW : Allows automatic gain control from 0 to 24dB.
- HIGH : Allows automatic gain control from 0 to 42dB.

### ● SENS-UP :

When it is night or dark, the camera automatically detects the light level and maintains a clear picture if this mode is activated.

- OFF : Deactivates the SENS-UP function.
- AUTO : Activates the SENS-UP function.

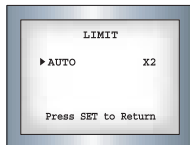

### ● RETURN :

Select this to save the changes in the EXPOSURE menu and return to the SETUP menu.

### Note

- If you press the SET button in 'AUTO' mode, You can adjust brightness by increasing or decreasing the shutter speed. (X2~X256)
- Note that the higher the zoom level, the brighter the screen, but the more likely it is that an after-image will appear.
- Although Noise, Spots, and Whitish symptoms may occur in SENS-UP operation when the zoom level is increased, this is normal.

## White Balance (White Bal.)

Use the White Balance function to adjust the screen colors.

1. Position the cursor to point to WHITE BAL on the SETUP menu screen, select using the Up and Down buttons.
2. Select a desired mode using the Up and Down buttons.

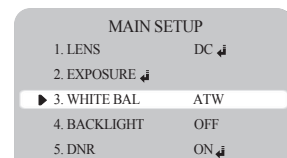

※ Select one of the following 5 modes, as appropriate.

- ATW : Select when the color temperature is between 1800°K and 10500°K
- INDOOR : Select when the color temperature is between 4500°K and 8500°K
- OUTDOOR : Select when the color temperature is between 1800°K and 10500°K. (sodium light inclusion)
- AWC SET : To obtain the optimum state under the current luminance levels, direct the camera to point toward a sheet of white paper and press the SET button. If the environment changes, including the light source, the white balance will require re-adjustment.
- MANUAL : Select to "fine-tune" the White Balance manually. Set White Balance first using the ATW or AWC mode. Afterwards switch to MANUAL mode, fine-tune the White Balance and then press the SET button.

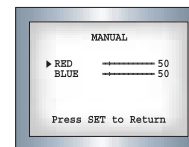

## How to Use the Camera

### Note

- Under the following conditions White Balance may not work properly. In such cases, select the AWC mode.
  - When the color temperature of the subject environment has a very high temperature range (e.g. clear sky, or sunset)
  - When the ambient illumination of the subject is low.
  - If the camera is directed toward a fluorescent light, or is installed in a place where illumination changes dramatically, the White Balance operation may become unstable.

## BACKLIGHT

This camera is designed to deliver a clear and distinct image of both subject and background, even when the subject is backlit, using a proprietary SV-IV DSP chip.

1. Position the cursor to point to BACKLIGHT on the SETUP menu screen using the Up and Down buttons.

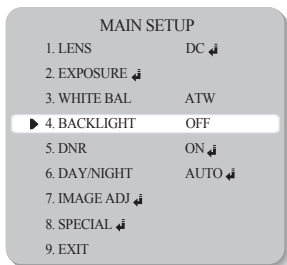

2. Select the desired mode using the Left and Right buttons.

- BLC : Enables a user to directly select a desired area from a picture, and to view the area more clearly.

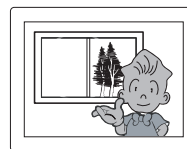

BLC ON



BLC OFF

- HLC (High Light Compensation) :  
If there is a high light installed in a limited environment such as an apartment parking garage or gas station entrance, removing the high light makes it possible to view car license plates efficiently.
  - DAY : In normal daylight conditions, the HLC is not activated.
  - NIGHT : If a high light that is larger than a certain size is present on the screen, remove the high light to see license plates clearly.

HLC MASKING AREA

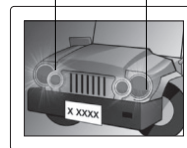

HLC ON

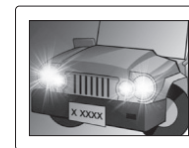

HLC OFF

- OFF : Not being used
3. Select a desired mode using the Left and Right buttons and press the SET button.
- Select 'BLC' to adjust the area to be enhanced and enhancement level.
  - HLC : Enable a user to select a mask color of high light area from a picture.

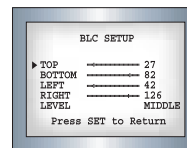

## How to Use the Camera

### Note

- Because there can be a difference in the effectiveness of HLC according to the amount of light area in the screen, optimize the installation angle for the best HLC performance.
- In a dark environment, the HLC is only activated when a high light that is larger than a certain area is present.
- The HLC is not activated in light or overly dark conditions.

## DNR

This function reduces the background noise in a low luminance environment.

1. When the SETUP menu screen is displayed, select 'DNR' using the Up and Down buttons.

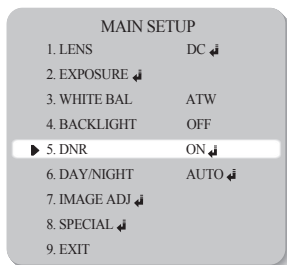

2. Select a desired mode using the Left and Right buttons.

- OFF : Deactivates DNR. Noise is not reduced.
- ON : Activates DNR so that noise is reduced.

3. Set the DNR mode to 'ON' and press the SET button. The noise reduction level can now be adjusted.

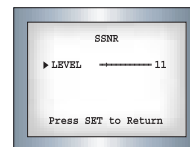

### Note

- You cannot set the DNR to 'ON' or 'OFF' when the AGC mode in the EXPOSURE menu is 'OFF'.
- When adjusting the noise reduction level in DNR mode, remember that the higher the level is set, the greater the reduction in noise level, but it also increases the possibility of ghosting.

## DAY/NIGHT

Pictures can be displayed in either color or black and white.

1. When the SETUP menu screen is displayed, select 'DAY/NIGHT' using the Up and Down buttons.

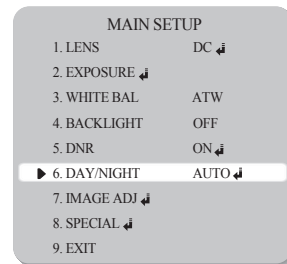

## ■ How to Use the Camera

2. Select the desired mode using the Left and Right buttons.

- **COLOR** : The picture is displayed in color.
- **B/W** : The picture is always displayed in black and white.
- **AUTO** : This camera has an IR Cut-Filter and automatically changes to the appropriate mode according to lighting levels. To set up the switching time and switching speed for the AUTO mode press the SET button.

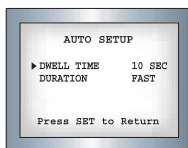

- **EXTERN** : This mode allows the application of a filter to external signals.

## IMAGE ADJ.

1. When the SETUP menu screen is displayed, select 'IMAGE ADJ.' using the Up and Down buttons.

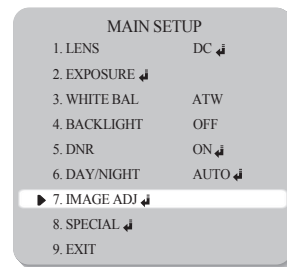

2. Select the desired mode using the Left and Right buttons.

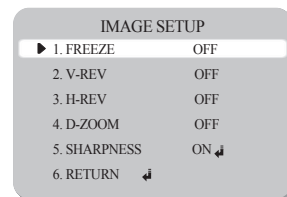

- **FREEZE** : View still pictures.
- **V-REV** : Flips the picture vertically on the screen.
- **H-REV** : Flips the picture horizontally on the screen.

## ■ How to Use the Camera

- **D-ZOOM** : Digitally zooms, the range is x1~x10.



- **SHARPNESS** : As this value is increased the picture outline becomes stronger and clearer.



- **RETURN** : Select this to save the settings for the IMAGE ADJ. menu and to return to the SETUP menu.

### Note

- When H-REV or V-REV is selected, any text in the picture also will be flipped horizontally or vertically.
- If the SHARPNESS level is increased too high the picture may become distorted, or noise may generated.

## SPECIAL

1. When the SETUP menu screen is displayed, select 'SPECIAL' using the Up and Down buttons.

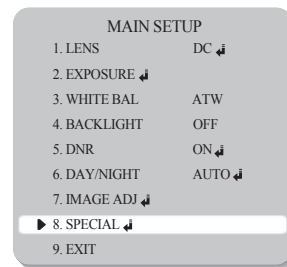

2. Select the desired mode using the Left and Right buttons.

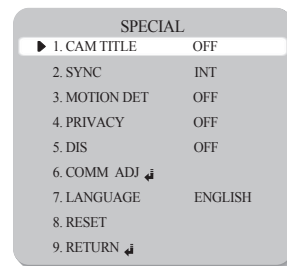

- **CAM TITLE** : If a title is entered, the title appears on the monitor.
  - ① When the SPECIAL menu screen is displayed, use the Up and Down buttons to point the cursor to 'CAM TITLE'.

## ■ How to Use the Camera

- ② Set to 'ON' using the Left and Right buttons.

### Note

- When the CAM TITLE menu is 'OFF', no title will be displayed on the monitor screen even if one has been entered.

SPECIAL	
▶ 1. CAM TITLE	OFF
2. SYNC	INT
3. MOTION DET	OFF
4. PRIVACY	OFF
5. DIS	OFF
6. COMM ADJ ↓	
7. LANGUAGE	ENGLISH
8. RESET	
9. RETURN ↓	

- ③ Press the SET button.

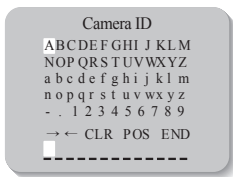

- ④ Use the 4 directional buttons to move to a character, and select it by pressing the SET button. Repeat this action to enter multiple characters. Up to 15 alphanumeric characters can be used.

### Note

- If the cursor is moved to CLR and the SET button pressed, all letters are deleted. To edit a letter, change the cursor to the bottom left arrow and press the SET button. Move the cursor over the letter to be edited, move the cursor to the letter to be inserted and then press the SET button.

- ⑤ Enter a title, move the cursor to 'POS' and press the SET button. The entered title appears on the screen. Select the position to display the title on the screen using the 4 directional buttons and press the SET button. When the position is determined, select 'END' and press the SET button to return to the SPECIAL menu.



- SYNC : In areas where the supply is 60Hz, multiple cameras using the power synchronisation function (Line-Lock), without using a synchronisation signal generator.

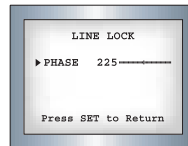

- INT : Internal Synchronisation Type
- L/L : Power Synchronisation Type, Line-lock
- Press the SET button.
- Select a phase between 0 and 359.

### Note

- When using AC power at a 60Hz frequency Line-Lock synchronisation can be used.
- When the power is DC 12V, the SYNC. menu is fixed to the 'INT' mode.

- MOTION DET:

Connecting an alarm device to this camera enables efficient activity monitoring, because a signal is generated by the camera whenever motion is detected.

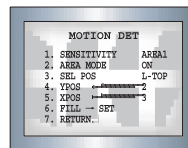

## ■ How to Use the Camera

- ① When the SPECIAL menu screen is displayed, press the Up and Down buttons so that the cursor points to MOTION DET.
- ② Set up the function using the 4 directional buttons.
  - SENSITIVITY : Select up to eight MD areas. When the SENSITIVITY value is high, motion detection sensitivity is increased to recognise small movements.
  - AREA MODE : Determines whether to use the MD area selected in SENSITIVITY.
  - SEL POS : Determines which of the 4 vertices of each MD area is to be used.
  - YPOS : Determines the co-ordinates of the vertical axis for SEL POS.
  - XPOS : Determines the co-ordinates of the horizontal axis for SEL POS.
  - FILL → SET : Fills in a selected MD area. Fills in a selected MD area. The color of filling is sequentially selected as brown, orange, blue, cyan, yellowish green, yellow and red.
  - RETURN : Select this to save the MOTION DET menu settings and return to the SPECIAL menu.



### Note

- MD areas show only on the MOTION DET menu. Therefore, MD areas are not displayed on the monitor screen.

- **PRIVACY** : Hide an area so that it is not displayed on the monitor.

- ① When the SPECIAL menu screen is displayed, press the Up and Down buttons so that the cursor points to 'PRIVACY'.

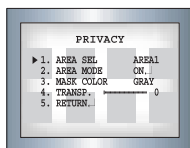

- ② Set up using the 4 directional buttons.
  - AREA SEL : Up to 8 areas are selectable.
  - AREA MODE : Determines whether to use the area selected in the AREA SEL, and the size and position of the area.

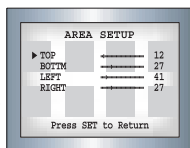

- MASK COLOR : Determine area color. Select Grey, Green, Red, Blue, Black or White.
- TRANSP : Determine the transparency of the selected area, the range is from 0 to 3.
- RETURN : Select this to save the PRIVACY menu settings and return to the SPECIAL menu.

- **DIS (Digital Image Stabilizer)** :

This function mitigates picture movement caused by external factors, such as wind.

- **COMM ADJ (Communication Adjustment)** :

This function sets up the camera communication status when controlling the camera through an external device.

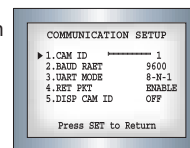

- ① When the SPECIAL menu screen is displayed, press the Up and Down buttons so that the cursor points to 'COMM ADJ'.
- ② Set up the mode using the 4 direction buttons.
  - CAM ID : Determines the camera's identification number (between 0 and 255).
  - BAUD RATE : Select 2400/4800/9600/19200/38400/57600 bps.
  - UART MODE : Select NONE, EVEN or ODD for the parity bits.
  - RET PKT : Determines whether to send a command back to the controller device when a communication control command is sent to the camera.
  - DISP CAM ID : Display the camera title on the top left corner of the screen.

- **LANGUAGE** : Select the appropriate menu language.

- **RESET** : Resets the camera settings to the factory defaults.

- **RETURN** : Select this to save the SPECIAL menu settings and return to the SPECIAL menu.

## EXIT

Press the SET button in the EXIT menu to save the current settings and exit the SET menu.

## ■ Troubleshooting

If you have trouble operating your camera, refer to the following table. If the guidelines do not enable you to solve the problem, contact an authorized technician.

Problem	Solution
Nothing appears on the screen.	<ul style="list-style-type: none"> <li>• Check the power connections.</li> <li>• Check the VIDEO signal line connection.</li> </ul>
The image on the screen is dim.	<ul style="list-style-type: none"> <li>• Make sure the lens is clean. Clean the lens with a soft clean lint free cloth.</li> <li>• Adjust the monitor contrast &amp; brightness controls.</li> <li>• Re-position the camera if necessary.</li> </ul>
The image on the screen is dark.	<ul style="list-style-type: none"> <li>• Adjust the contrast control of the monitor.</li> <li>• If you have an intermediate device, set the 75Ω/ Hi-z properly.</li> </ul>
The camera is not working properly, and the surface of the camera is hot.	<ul style="list-style-type: none"> <li>• Check that an appropriate power source is connected to the camera.</li> </ul>
The DAY/NIGHT menu does not work.	<ul style="list-style-type: none"> <li>• Check that AGC in the EXPOSURE menu is set to 'OFF'.</li> </ul>
The SENS-UP function does not work.	<ul style="list-style-type: none"> <li>• Check that AGC in the EXPOSURE menu is not set to 'OFF'.</li> <li>• Check that SHUTTER in the EXPOSURE menu is not set to 'A.FLK' or 'MANUAL'.</li> </ul>

Problem	Solution																
The Motion Detection function does not work.	<ul style="list-style-type: none"> <li>• Check that MOTION DET in the SPECIAL SETUP is not set to 'OFF'.</li> </ul>																
Color is not correct.	<ul style="list-style-type: none"> <li>• Check the WHITE BAL settings in the SETUP menu.</li> </ul>																
The screen flickers continually.	<ul style="list-style-type: none"> <li>• Check that direction of camera turns toward the Sun.</li> </ul>																
RS-485 communication fails.	<ul style="list-style-type: none"> <li>• Check the polarity between the RS-485 Control Port and the RS-485 cable. <table border="1" data-bbox="1123 488 1489 544"> <thead> <tr> <th>485 Control Board Connection Port</th> <th>RS-485 Control Port</th> </tr> </thead> <tbody> <tr> <td>(+) CONNECTION TERMINAL (TRX+)</td> <td>485+</td> </tr> <tr> <td>(-) CONNECTION TERMINAL (TRX-)</td> <td>485-</td> </tr> </tbody> </table> </li> <li>• Check the RS-485 Communication default settings. <ul style="list-style-type: none"> <li>* RS-485 Communication default settings are: <table border="1" data-bbox="1123 630 1489 669"> <thead> <tr> <th>Item</th> <th>Camera ID</th> <th>BAUD RATE</th> <th>UART MODE</th> <th>RET PKT</th> </tr> </thead> <tbody> <tr> <td>Initial value</td> <td>1</td> <td>9600</td> <td>8-NONE-1</td> <td>ENABLE</td> </tr> </tbody> </table> </li> </ul> </li> </ul>	485 Control Board Connection Port	RS-485 Control Port	(+) CONNECTION TERMINAL (TRX+)	485+	(-) CONNECTION TERMINAL (TRX-)	485-	Item	Camera ID	BAUD RATE	UART MODE	RET PKT	Initial value	1	9600	8-NONE-1	ENABLE
485 Control Board Connection Port	RS-485 Control Port																
(+) CONNECTION TERMINAL (TRX+)	485+																
(-) CONNECTION TERMINAL (TRX-)	485-																
Item	Camera ID	BAUD RATE	UART MODE	RET PKT													
Initial value	1	9600	8-NONE-1	ENABLE													

## ■ Specifications

		NTSC		PAL	
Power Source	AC24V / DC12V	DC12V	AC24V / DC12V	DC12V	
	300mA(AC24V)/450mA(DC12V)	400mA	300mA(AC24V)/450mA(DC12V)	400mA	
CCD	Size	SONY 1/3" Super HAD High Sensitivity Color CCD			
	Total Pixels	811(H) x 508(V)		795(H) x 596(V)	
	Effective Pixels	768(H) x 494(V)		752(H) x 582(V)	
Sync	Scanning System	2:1 Interlace			
	Synchronization	Internal / Line Lock			
	Frequency	Horizontal : 15.734 KHz, Vertical:59.94 Hz		Horizontal : 15.625 KHz, Vertical:50.00 Hz	
O.S.D	Korean, English, Japanese, Spanish		English, French, German, Spanish, Italian, Chinese		
E L E C T R I C A L	Backlight Comp.	OFF/BLC/HLC			
	Resolution	Color : 580 TV Lines		B/W : 700 TV Lines	
	S/N (Y signal)	52 dB (AGC Off, Weight ON)			
	Min. Illumination	0.15Lux(40IRE Color), 0.01Lux(40IRE B/W), 0.0001Lux(40IRE Sense-upX256) at F1.2			
	White Balance	ATW / AWC / Manual / Outdoor / Indoor (1800°K ~10,500°K)			
	Electronic Shutter Speed	1/60 ~ 1/120,000 sec		1/50 ~ 1/120,000 sec	
	Sens-up	AUTO / OFF (Selectable x2 ~ x256)			
	Gain Control	LOW / HIGH / OFF			
	DNR	ON / OFF (1~32 Level)			
	Motion Detection	ON / OFF (8 Zone, ALARM Output)			
	Privacy	ON/OFF (8 Zone)			
	V-REV	ON / OFF			
	H-REV	ON / OFF			
	Freeze	ON / OFF			
	Sharpness	ON/OFF (Level Adjustable)			
	Day & Night	COLOR / Black& White/AUTO/EXT			
	DIS	OFF / ON			
Digital Zoom	OFF / ON(x10)				
Operating Temperature / Humidity	-10°C to +50°C / 30% to 80% RH				
Storing Temperature / Humidity	-20°C to +60°C / 20% to 90% RH				
Weight	Approx. 350g				



---

**Modle : HTC-T16G28D**

# **Super DNR High Resolution Day/Night Dome Camera**

**Instruction Guide**

---

**Modle : HTC-T16G28D**  
**Super DNR High Resolution Day/Night Dome Camera**

---

Printed in KOREA